

REV.	DESCRIPTION	DATE
A	NEW DRAWING	7/30/2007

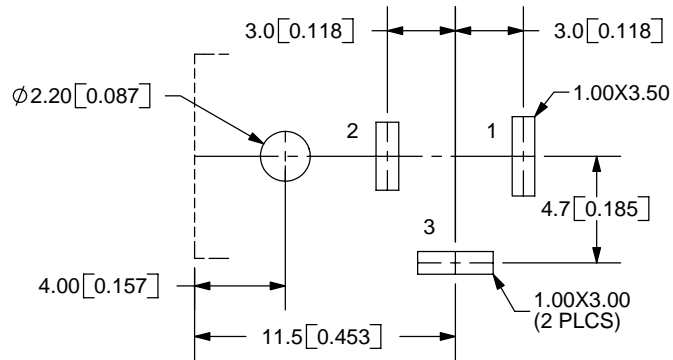

PCB LAYOUT  
TOP VIEW

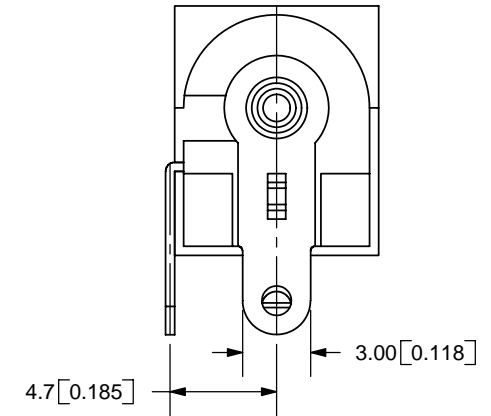
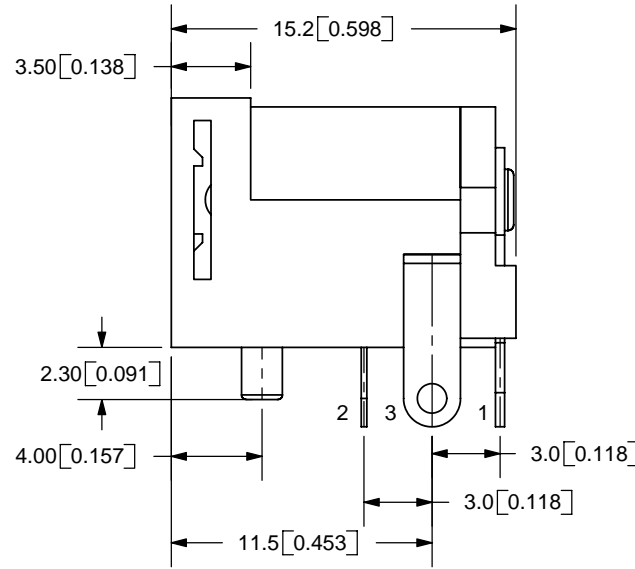
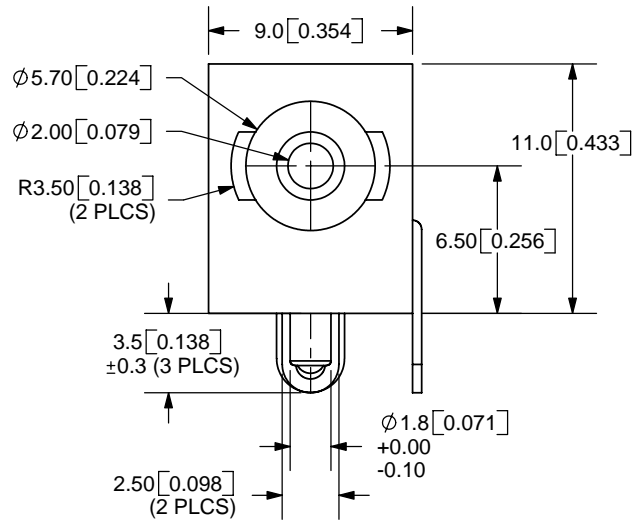
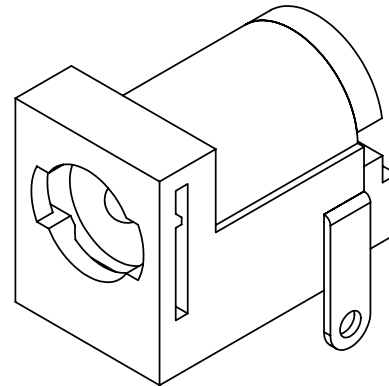

TOLERANCE:  
X.X±0.2mm  
X.XX±0.1mm  
X.XXX±0.05mm



MODEL NO.	PJ-058A
SCHMATIC	

CENTER PIN DIAMETER 2.00mm Dia.

**SPECIFICATIONS:**  
RATING: 16V DC @ 2.5A  
CONTACT RESISTANCE: 50m OHMS MAX  
INSULATION RESISTANCE: 100M OHMS MIN: 500V DC  
VOLTAGE WITHSTAND: 500V AC R.M.S. FOR 1 MINUTE  
LIFE: 5,000 CYCLES

	MATERIAL	PLATING
CENTER PIN	Copper	Nickel
TERMINAL 1	Brass	Tin
TERMINAL 2	Copper Alloy	Tin
TERMINAL 3	Brass	Tin
BODY	PBT	



20050 SW 112th Ave.  
Tualatin, OR 97062  
Phone: 503-612-2300  
800-275-4899  
Fax: 503-612-2383  
Website: www.cui.com

TITLE: DC POWER JACK	REV: A
PART NO. PJ-058A	UNITS: MM [INCHES]
DRAWN BY: ZRJ	APPROVED BY:
	SCALE: 3:1

PC FILE NAME:  
PJ-058A

COPYRIGHT 2007 BY CUI INC.